

COMPACT
DESIGN

PT100 MODBUS TEMPERATURE TRANSMITTER THM501

REF.: PA151700100



The Tekon Electronics In Head Temperature Transmitters are specifically designed to meet the most rigorous requirements of operation in the industrial process environments. Due to their reduced dimensions they can be installed in the the DIN Form B sensor connection head in place of traditional terminal blocks.

The THM501 is a temperature transmitter which accepts exclusively PT100 temperature sensors (Resistance thermometers with 2,3 or 4-wire configuration), and make it available in a Modbus RTU slave register.

Dimensions 45Ø x 23 mm

Weight: Approx. 50g

Material: Nylon 66

Protection Index: IP40

KEY FEATURES

PT100 SENSOR INPUT

2, 3 AND 4 WIRES

MODBUS RTU SLAVE PROTOCOL

RS-485

INSTALLATION IN DIN B TYPE CONNECTION HEAD

CONTINUOUS OPERATING STATUS MONITORING AND SELF-DIAGNOSTIC

HIGH PRECISION AND ACCURACY

> 16 BITS / < 0,1°C

WIDE MEASUREMENT RANGE

-200°C TO 850°C

CONFIGURABLE OVER PC

TEKON CONFIGURATOR SOFTWARE

DS_INHD_THM501_E01B

TECHNICAL SPECIFICATIONS

SENSOR INPUT - RESISTANCE THERMOMETER (RTD)

Measured variable	Temperature
Sensor type	PT100
Connection	2 wires, 3 wires or 4 wires
Units	°C or °F
Sensor current	600uA (2 or 4 wires); 300uA (3 wires)
Response time	<100 ms
Open-circuit monitoring	Always active (cannot be disabled)
Short-circuit monitoring	Always active (cannot be disabled)
Measuring range	-200°C to 850°C (-328°F to 1562°F)

MEASUREMENT ACCURACY

Reference conditions	
Power supply	24V DC \pm 1%
Ambient temperature	23°C (73,4°F)
Warm-up time	>5min
Accuracy °C [°F]	<0,1°C (0,18°F)
Temperature coefficient	<+/- 0,01°C/°C

OUTPUT - MODBUS

Physical layer	RS-485
Slave address range	From 1 to 100
Support baud rates	4800, 9600, 19200, 38400, 56000, 57600, 115200
Supported parity	Odd/Even/None
Stop bits (not configurable)	2 if parity NONE; 1 if parity ODD or EVEN
Response time	<100ms
Communication start up time (after power ON) ¹	10s

OPERATING ENVIRONMENT

Ambient temperature range	-20 to 80°C (-4 to 176°F)
Storage temperature range	-20 to 80°C (-4 to 176°F)
Relative humidity	≤95%, without condensation

MODBUS TABLE (HOLDING REGISTERS)

Description	Address	Type	Values
Acquisition mode configuration	15	UINT16	3 - PT100 2W 4 - PT100 3W 5 - PT100 4W
Temperature format configuration	18	UINT16	1 - °C 2 - °F 3 - K
Temperature value	23	DOUBLE32 (BA DC)	

¹ Ten seconds window, after power ON, to enter in configuration mode using Tekon Configurator Software.

FACTORY DEFAULT SETTINGS

Sensor	PT100 with 3-wire circuit
Temperature format	Celsius [°C]
Modbus settings	
Baudrate	9600 bps
Parity	None
Data bits	8
Stop bits	2
Slave address (Node Index)	1
Modbus register - Value	
Acquisition mode configuration	4
Temperature format configuration	1

CERTIFICATIONS AND APPROVALS

EN 61326	Electrical equipment for measurement, control and laboratory use. EMC requirements.
IEC 61000-4-2	Electrostatic discharge immunity test
IEC 61000-4-3	Radiated, radio-frequency, electromagnetic field immunity test
IEC 61000-4-4	Electrical fast transient/burst/immunity test
IEC61000-4-5	Surge immunity test

POWER SUPPLY

Power supply	12 to 24 V DC $\pm 10\%$
Power consumption	< 0,3 W

CASING

Material	Nylon 66
Weight	Approx. 50g
Dimensions	See "Dimensional drawings"
Cross section	2.5 mm ²
Protection index	IP40

TECHNICAL DRAWINGS AND INFORMATION

DIMENSIONAL DRAWINGS & INSTALLATION DIAGRAM

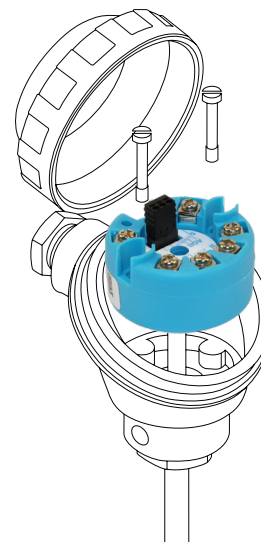
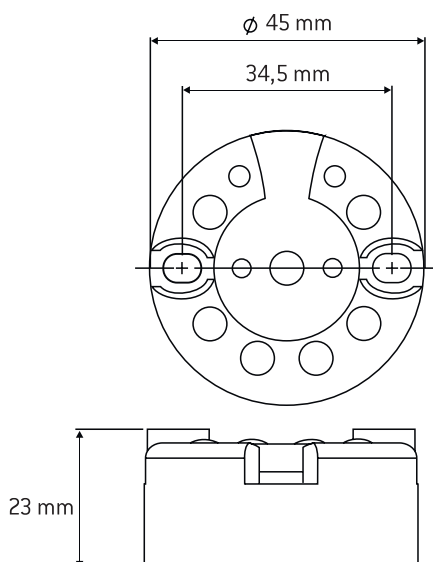

ELECTRICAL CONNECTIONS

RESISTANCE THERMOMETER

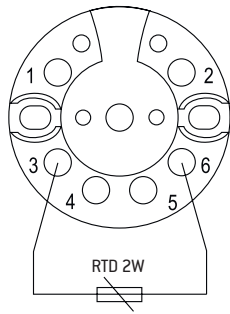

RS485

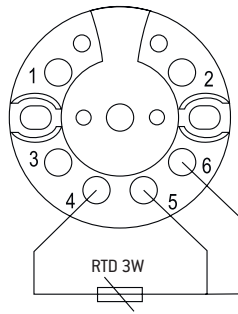

POWER SUPPLY

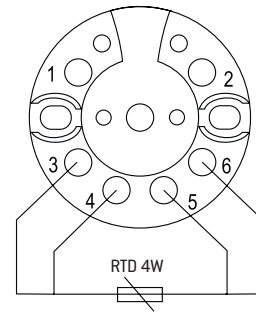

W = WIRES

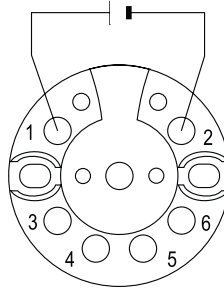
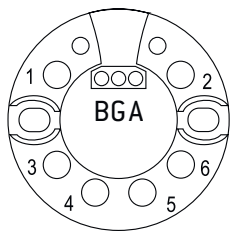

A: - TxD-/RxD-
B: + TxD/RxD+
G: C common signal reference ground

BLOCK DIAGRAM

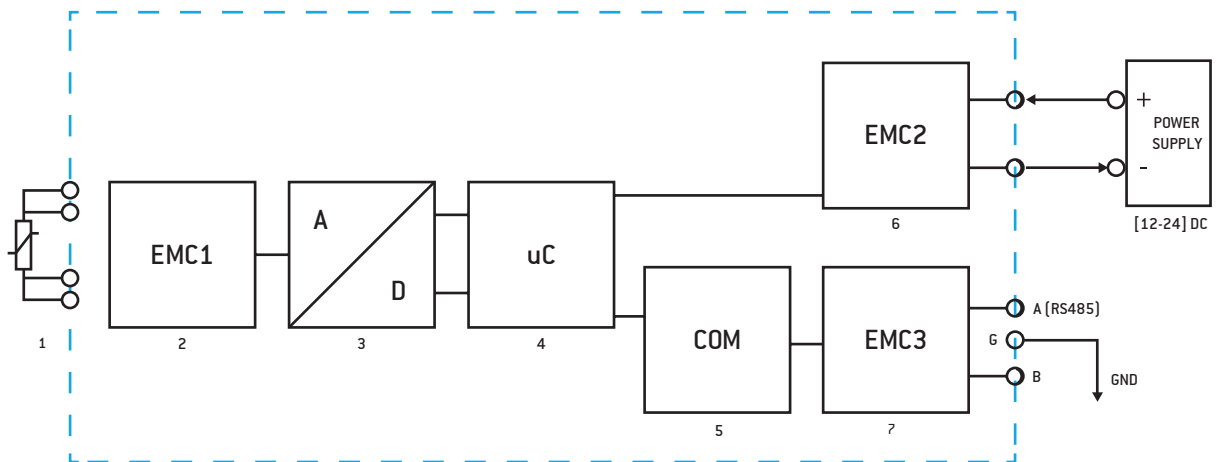

- 1 - Sensor (RTD)
- 2 - Sensor input EMC1 protection module
- 3 - Analog-Digital converter (16 Bits)
- 4 - Microcontroller

- 5 - Communication module
- 6 - EMC2 protection module
- 7 - EMC3 protection module

RELATED PRODUCTS



RS485 TO USB CONVERTER CABLE

REF.: PA123790400

Cable to connect THM501 temperature head transmitter to USB port.

REVISION HISTORY

VERSION

E01B	<ul style="list-style-type: none">- Replacement of "SARC1105 - USB CONFIGURATOR" to "RS485 TO USB CONVERTER CABLE" in Related Products;- "7 - EMC3 protection module" subtitle added;- "Modbus Configuration" table deleted. Information incremented in "Output - Modbus" table;- "Modbus Configuration" table deleted. Information incremented in "Output - Modbus" table;- "Factory Settings" table renamed to "Factory Default Settings";- In "Casing" table, protection type renamed to protection index;- In "Casing" table, cross-selection of cables renamed to cross section;- Power consumption feature added in "Power Supply" table;- In "Measurement accuracy" table, error due to internal cold junction information removed
------	---

TEKON ELECTRONICS
a brand of Bresimar Automação S.A.

Quinta do Simão
3800-230 Aveiro
PORTUGAL

P.: +351 234 303 320
M.: +351 933 033 250
E.: sales@tekonelectronics.com

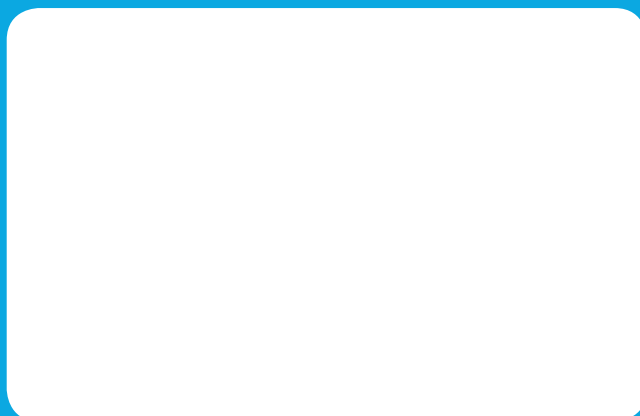

Cofinanciado por:



UNIÃO EUROPEIA
Fundo Europeu
de Desenvolvimento Regional